

# WALL CAP SHEET 1 - LAST REVISION 1/2/07

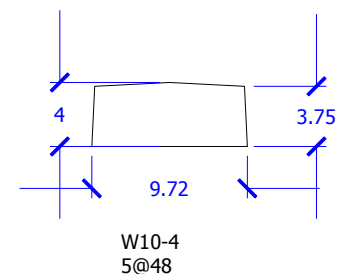

882 N. Marshall Way  
Layton, UT 84041  
Ph. (801) 544-9054  
Fax: (801) 544-9154

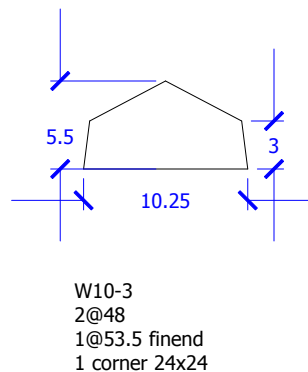
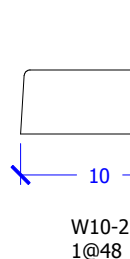
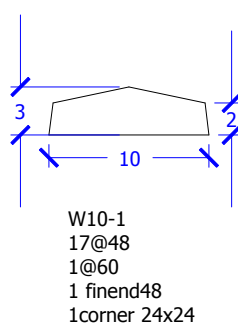
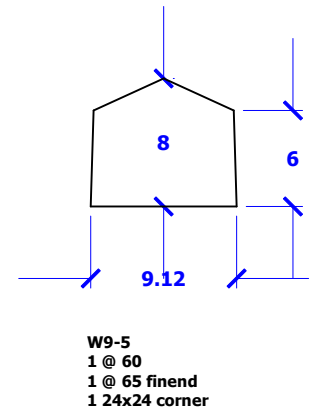
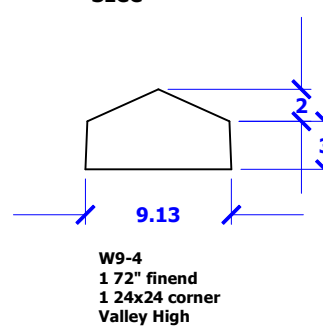
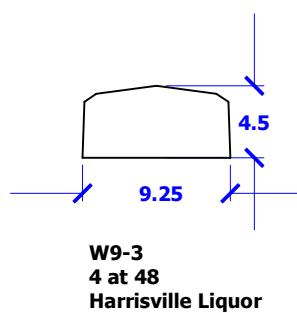
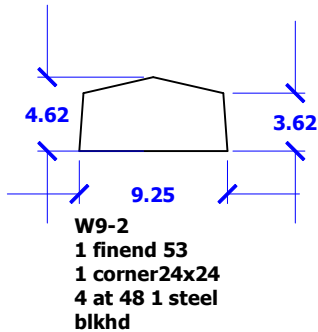
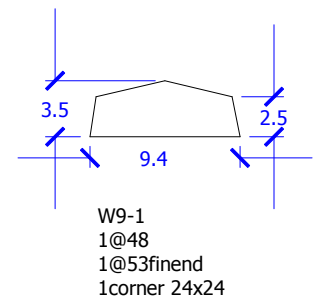
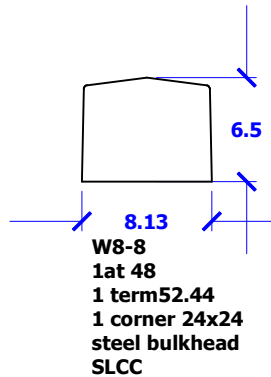
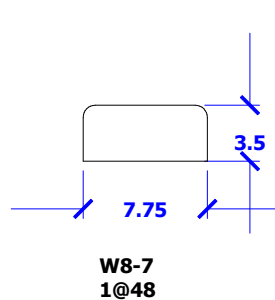
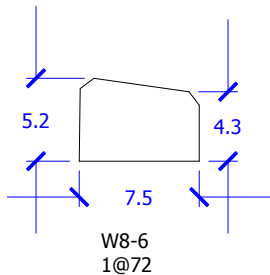
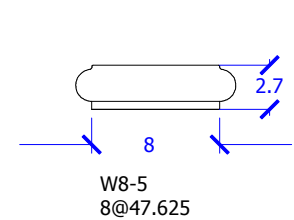
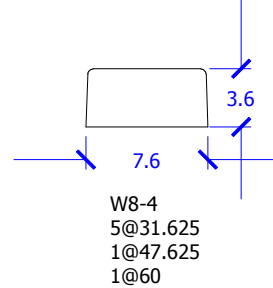
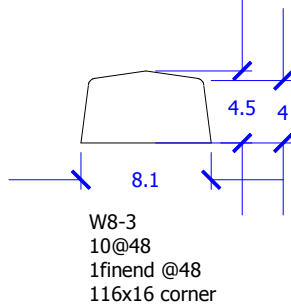
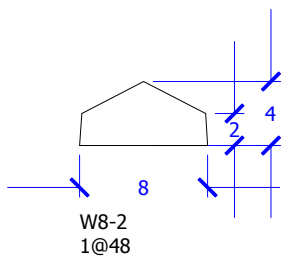
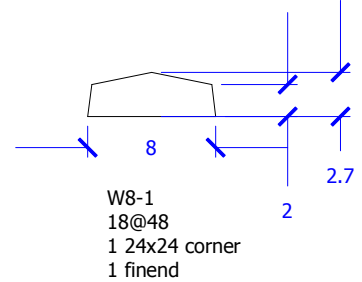
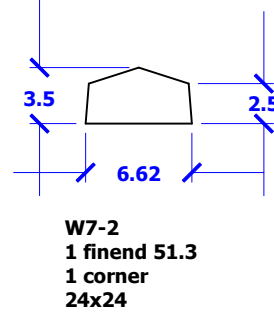
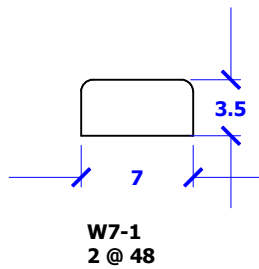
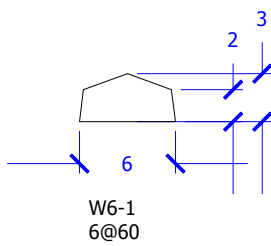
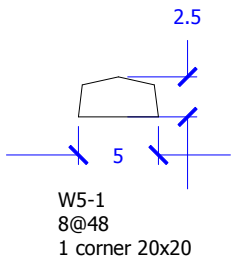

# WALL CAP SHEET 2 - LAST REVISION 1/2/07



882 N. Marshall Way  
Layton, UT 84041  
Ph. (801) 544-9054  
Fax: (801) 544-9154

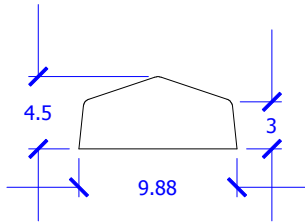

W10-5  
10@48

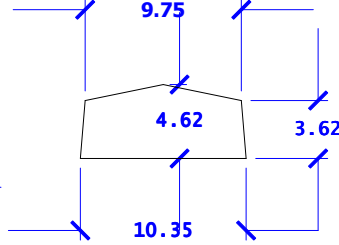

W10-6  
5 @47.625  
1 @ 60  
1 finend 53.125  
Steel Bulkhead  
24x24 corner

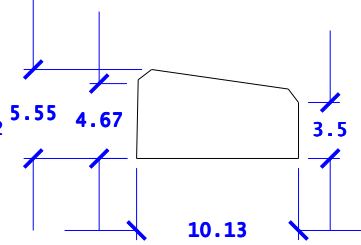

W10-7  
1@ 72

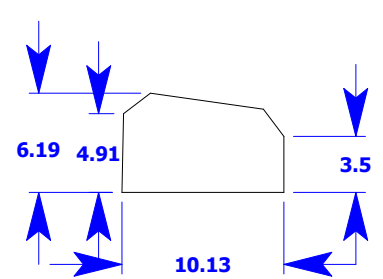

W10-8  
1 @ 72

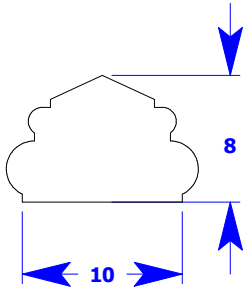

W10-9  
10 @ 47.625

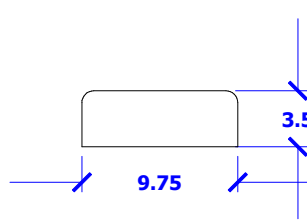

W10-10  
1@48

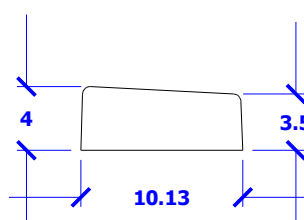

W10-11  
3 @ 47.625

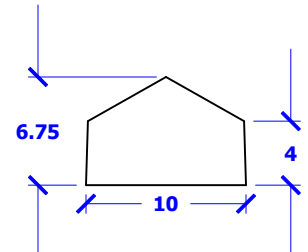

W10-12  
1 @ 48  
1 @ 53.375 finend  
1 corner 24x24

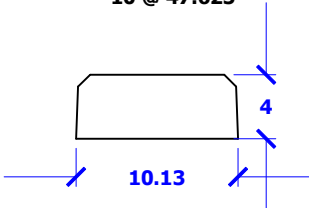

W10-13  
3@48  
1 finend 49.25  
1 steel bulkhead

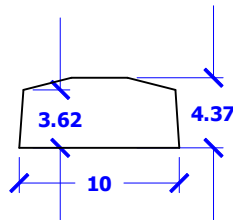

W10-14  
1@48  
1@51.625 term  
1 steel bulkhead

Hooper Elementary

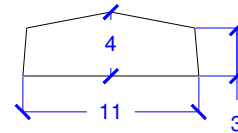

W11-1  
8@48, 1@60  
2 24x24 crnr,  
2 finend

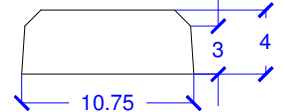

W11-2  
4@ 48"  
2 36" with  
6"step

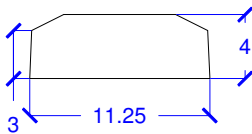

W11-3  
1 @48"  
1 24x24 corner  
1 finend 50.5  
1 Steel Bulkhead

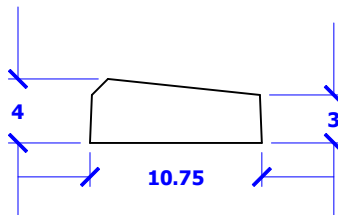

W11-4  
6 @ 47.625"  
rightfinend 50.13"  
leftfinend 50.13"  
Incorner 24x24

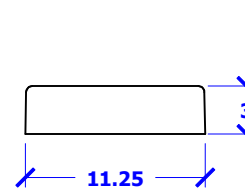

W11-5  
2 @ 67.5"

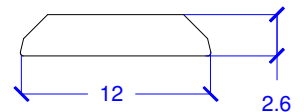

W12-1  
2 @60" +  
finends

# WALL CAP SHEET 3 - LAST REVISION 1/2/07



882 N. Marshall Way  
Layton, UT 84041  
Ph. (801) 544-9054  
Fax: (801) 544-9154

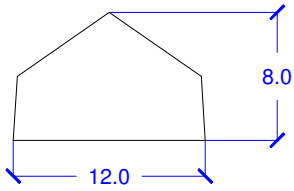

**W12-2**  
1@48"  
1 corner

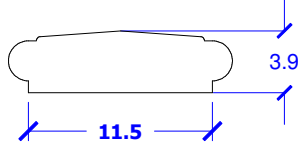

**W12-3**  
1@48"  
1@12" finend  
2@12"  
curved  
mold

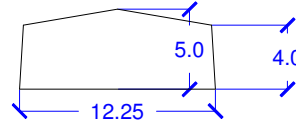

**W12-4**  
20@48"  
1@60  
3 finends @54.5  
45deg 6' idcurve  
15deg 20' idcurve  
22.5 deg  
12'ridgediamcurve  
3 24x24 corner

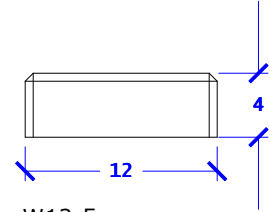

**W12-5**  
2@72" Chamfered  
ends

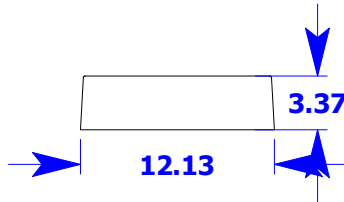

**W12-6**  
8 @72

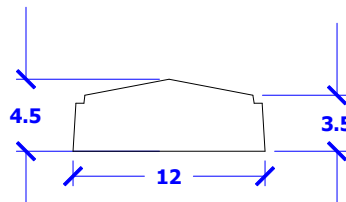

**W12-7**  
1 Finend@56  
1 corner 24x24  
(Bjb 8772)

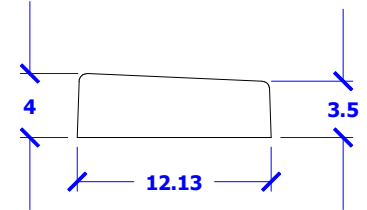

**W12-8**  
2 @47.625  
2 steel bulkheads

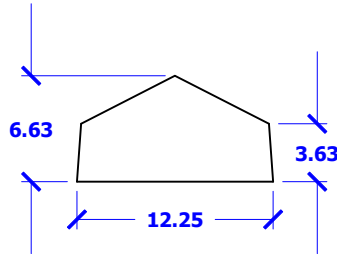

**W12-9**  
1 straight 48  
1 finend 54.5  
1 corner 24x24

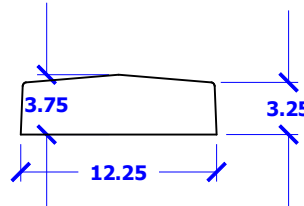

**W12-10**  
1 at 54.5 termination  
1 steel bulkhead

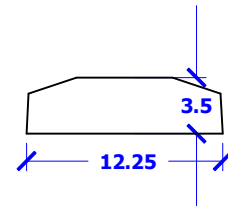

**W12-11**  
1 one mold 75-80  
Stonegate 37

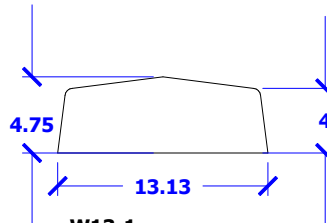

**W13-1**  
10 @ 48"  
2 Finend @54.75  
2 16x16 corner

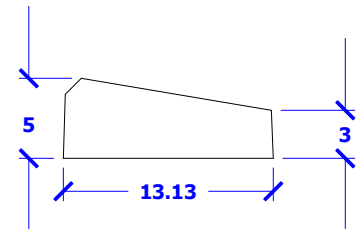

**W13-2**  
4 @48"  
1 incorner 24x24

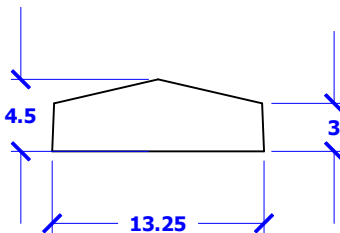

**W13-3**  
5 @ 48  
1 @ 55 finend  
1 corner 24x24

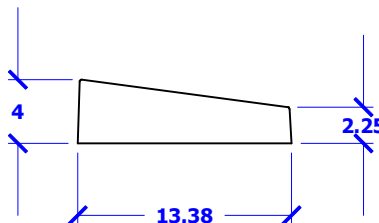

**W13-4**  
4 @48  
1 corner ridge out 24x24

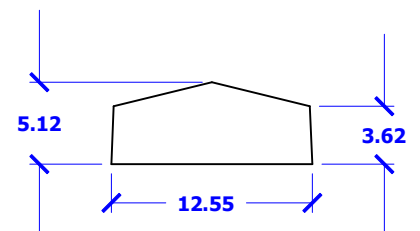

**W13-5**  
3 @ 48  
1 finend @ 54.625  
1 corner 24x24

# WALL CAP SHEET 4 - LAST REVISION 1/2/07



882 N. Marshall Way  
 Layton, UT 84041  
 Ph. (801) 544-9054  
 Fax: (801) 544-9154

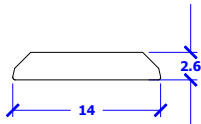

**W14-1**  
 60" + finend

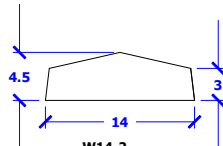

**W14-2**  
 1 @ 47.5"

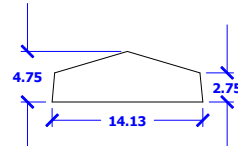

**W14-3**  
 10 @ 48"  
 Finend 55"  
 1 Corner 24x24

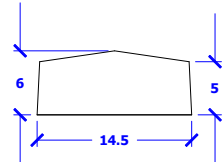

**W14-4**  
 1 @ 48  
 1 @ 55.625 finend  
 1 corner 24x24  
 2 Bulkheads

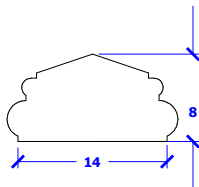

**W14-5**  
 4 @ 31.625 Straight  
 1 @ 13'8" ridge rad x 30" nom  
 2 @ 29'2" ridge rad x 32" nom

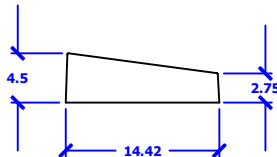

**W14-6**  
 2 urethane molds 20' outside  
 diameter 11 degree sweep

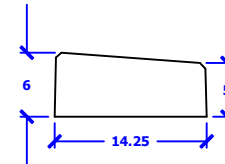

**W14-7**  
 6 at 48"

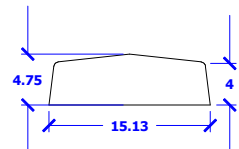

**W15-1**  
 1@48

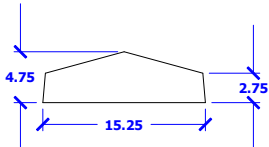

**W15-2**  
 2 @ 48  
 1 @ 53.625 Finend

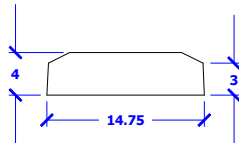

**W15-3**  
 4 @ 48"  
 1 24x24 corner

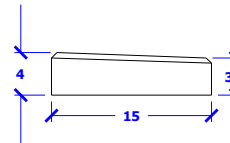

**W15-4**  
 1@96 w/2 finends

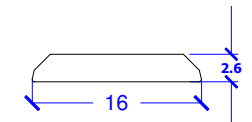

**W16-1**

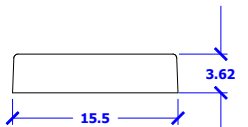

**W16-2**  
 1 @ 36"

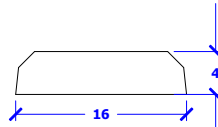

**W16-3**  
 2 @ 36+ finend  
 Molds unfinished

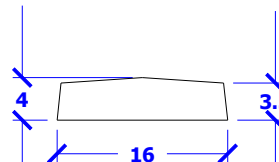

**W16-4**  
 3 @ 48"  
 1 finend 56.375  
 steel bulkhead

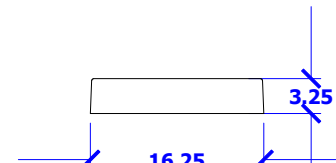

**W16-5**  
 1 @ 72"  
 w16-8 is  
 compatible  
 swept low

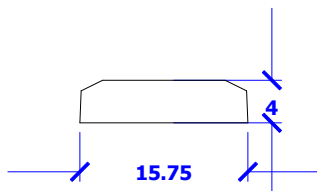

**W16-6**  
 3 @ 48"

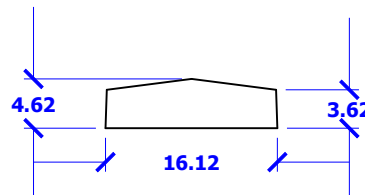

**W16-7**  
 1 finend 56.44  
 1 corner 24x24

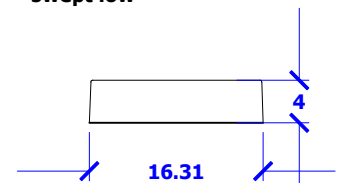

**W16-8**  
 6 at 48 Monache  
 compatible with  
 W16-5 if swept

# WALL CAP SHEET 5 - LAST REVISION 1/2/07



882 N. Marshall Way  
Layton, UT 84041  
Ph. (801) 544-9054  
Fax: (801) 544-9154

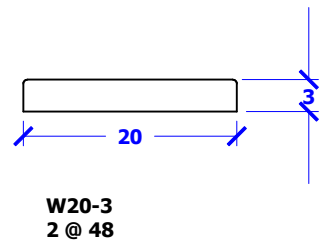
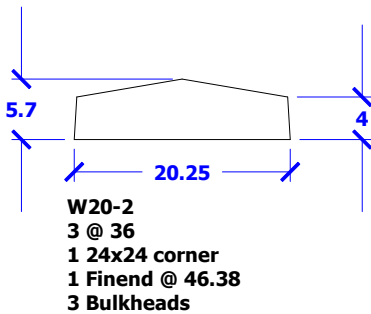
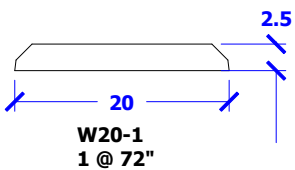
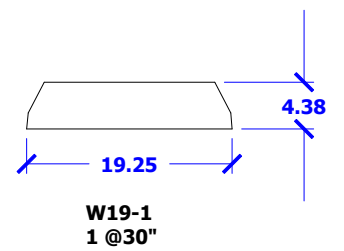
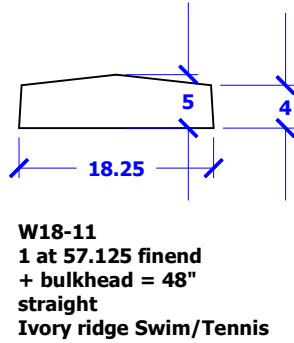
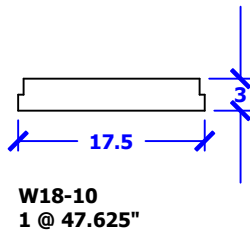
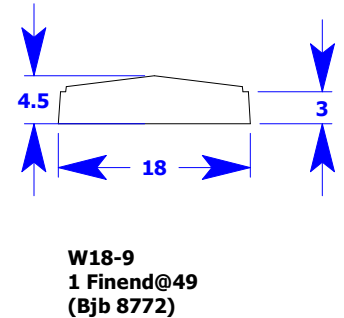
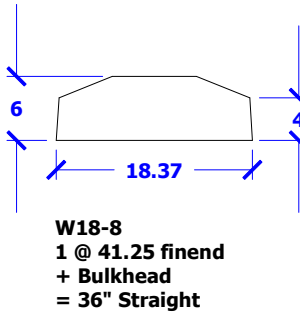
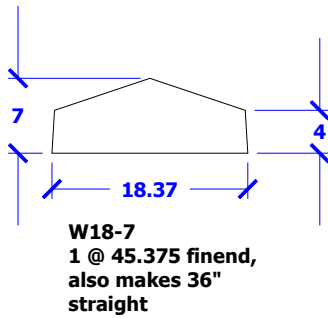
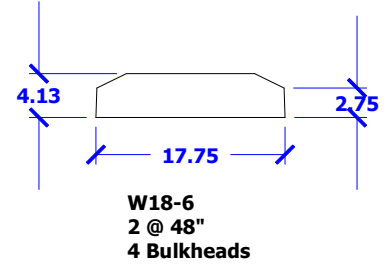
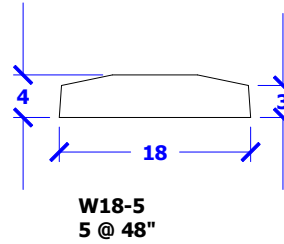
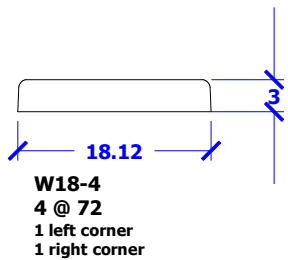
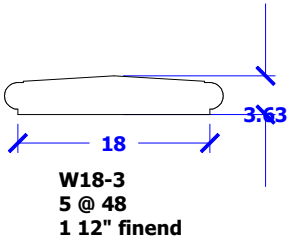
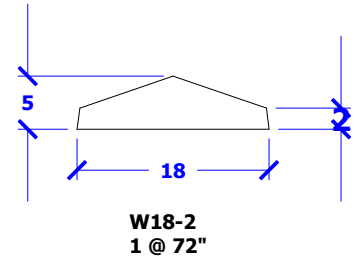
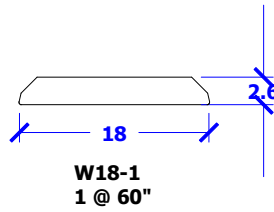
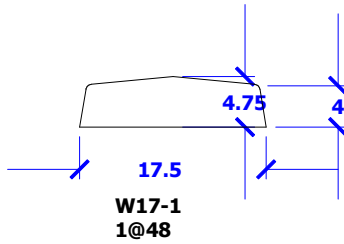

# WALL CAP SHEET 6 - LAST REVISION 1/2/07



882 N. Marshall Way  
Layton, UT 84041  
Ph. (801) 544-9054  
Fax: (801) 544-9154

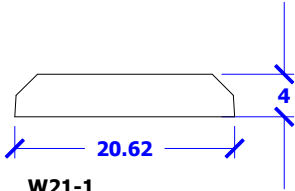

**W21-1**  
1 @ 40 finend  
Bulkhead

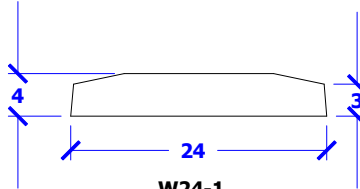

**W24-1**  
2 @ 36"

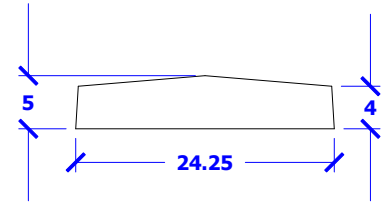

**W24-2**  
1 @ 36", 1 @ 48.5 finend  
Ivory Ridge Swim  
Tennis

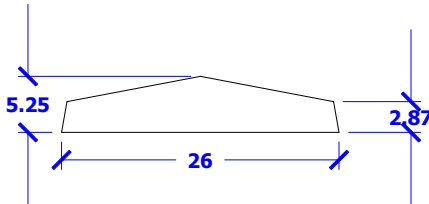

**W26-1**  
1 @ 30"

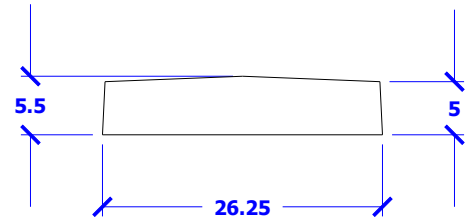

**W26-2**  
1 finend @ 37.5  
1 bulkhead

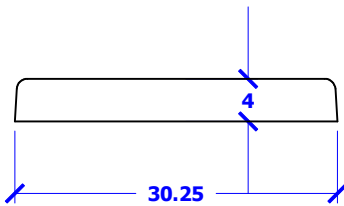

**W30-1**  
1 @ 96.25 bench mold  
finends and corners  
max straight 92"

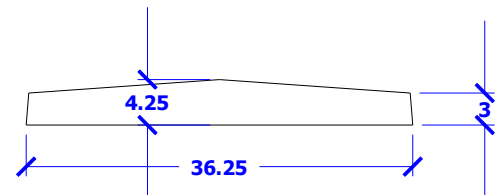

**W36-1**  
1 @ 60"

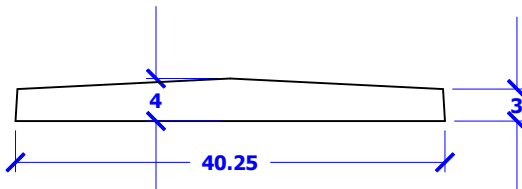

**W40-1**  
PC40-2 compatible  
2 at 96  
condos at the canyons

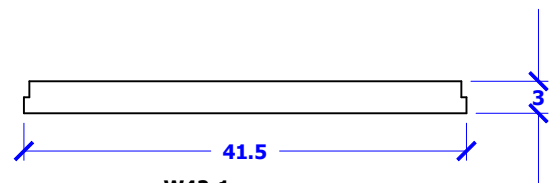

**W42-1**  
4 @ 29"  
4 @ 17.75"  
2 @ 15.5"  
used as Wainscot